

Edelweiss Austrian Jacket for 18" Doll

Created by Anne Tucker Blake



Click [HERE](#) to see the back view.

MATERIALS:

1 skein Dalegarn Baby Ull, 100% wool, 175m/50gm, white or desired color; 20 yards of same yarn in contrast color. Size 1 straight or circular needles, 1 set size 1 double-pointed needles or size to obtain gauge. Size 3 crochet hook. Cable needle. DMC Pearl #8 or sock and heel reinforcement yarn in assorted colors for embroidery. Six 3/8" heart-shaped buttons.

GAUGE:

Using Size 1 needles, 8 stitches and 12 rows to 1" in stockinette stitch.

GLOSSARY:

St st	Stockinette stitch.
reverse St st	Purl on the right side, knit on the wrong side.
sl1	Slip 1 stitch as if to purl, unless told to do otherwise.
Bl	Bar increase: lift yarn between 2 stitches, place on tip of left needle, knit or purl into back loop.
SSK	Slip next two stitches knitwise, one at a time, insert left needle into the fronts of these two slipped sts and knit them together
k2 tog	Knit 2 stitches together.
BO	Bind off.
DBO	Double bind off: Hold the 2 needles with the sts you are binding-off parallel to each other.

The working yarn should be coming from the end of one of the needles. Using a spare needle, knit one st from the front needle together with one st from the back needle. *Knit the next two sts, one from the front and one from the back needle, together. There will be 2 sts on the right needle. Slip the first st over the second st. Repeat from * effectively knitting together and binding-off at the same time.

PATTERN STITCHES:

Seed st Row 1: k1, p1;
All following rows: knit the purl sts and purl the knit sts.

Mistake Rib (mrib): Multiple of 4 sts + 1 st
Row 1 (RS): *k2, p2; rep from * to last st, k1

Row 2: Repeat Row 1

See the **Mistake Rib** chart.

Braided Cable (BC): Multiple of 6 sts worked over 8 rows.

Row 1: K6

Row 2: P6.

Row 3: Slip 2 sts to cable needle, hold in front, k2, k2 from cable needle, k2

Row 4: P6

Row 5: K2, slip 2 sts to cable needle, hold in back, k2, k2 from cable needle

Row 6: P6

Row 7: Slip 2 sts to cable needle, hold in front, k2, k2 from cable needle, k2

Row 8: P6

Repeat Rows 3 - 6 for pattern.

See the **Braided Cable** chart.

Bobble Pattern (BP) :

3 Stitch

Multiple of 3 sts

Row 1: P3

Row 2: K3

Row 3: P1, work [k, p, k] in next st, p1

Row 4: K5

Row 5: P1, pass 2nd and 3rd sts over next st on left hand needle, p1

Row 6: K3

5 Stitch

Multiple of 5 sts

Row 1: P5

Row 2: K5

Row 3: *P1, work [k, p, k] in next st, rep from *, p1

Row 4: K9

Row 5: *P1, pass 2nd and 3rd sts over next st on left hand needle, rep from *, p1

Row 6: K5

See the **Bobble Chart**.

For both 3 and 5 Stitch BP work Rows 1 & 2 once and repeat Rows 3 - 6.

Back

Cast on 67 sts.

Row 1 (The Foundation Row):

K1 (selvage st**), 20 sts mrib, starting with k1, (p2k2) repeat; work center 25 sts as follows:

{k1, BP 3, BC 6, BP 5, BC 6, BP 3, k1} (center panel pattern); work 20 sts mrib starting with (p2k2) repeat across, end k1 (selvage st).

**NOTE :

Work 1 stitch (selvage stitch) on each edge of body and sleeves (except button band) in stockinette.

All increases and decreases are done inside this single stitch with a bar increase (BI), knit 2 together (k2 tog) or slip, slip, knit (SSK).

Keeping the stitch patterns consistent as established on the Foundation Row, follow the charts or written instructions for each pattern and continue as follows:

Rows 2 - 10: Dec 1 st each edge on Rows 3, 5, 7, 9 -- k1, k2 tog, work to last three stitches, ssk, k1

Rows 11 - 13: Work in pattern

Rows 14 - 26: Inc 1 st each edge on Rows 14, 18, 22, 26 -- p1, BI, work to last stitch, BI, p1.

Work new sts in mrib.

Shape Yoke

Row 27 (RS): K1, work 19 sts mrib, k2 tog, BP 3, BC 6, [p1, (work k,p,k in next st), Blpurl, p1, Blpurl, (work k,p,k in next st), p1]

Note:

The BP 5 is now BP 3, p1, BP 3}, BC 6, BP 3, ssk, 19 mrib, k1.

Continue to work in this manner, decreasing in the mrib sts just before (last two mrib sts) and just after (first two mrib sts) the center pattern panel and increasing after the 1st bobble and before the 2nd bobble of the {BP 3, p1, BP 3} portion of center pattern panel established on Row 27 above. Keep the added sts in reverse stockinette st and work the ssk and k2 tog as purl on the wrong side.

AT THE SAME TIME, BO 4 sts at the beg of Rows 31 & 32. Decrease 1 st each edge on Rows 33, 35, 37, 39.

Work in established patterns on 51 sts through Row 66. Place sts on holder.

Sleeves :

Cast on 44 stitches.

Row 1 (The Foundation Row): K1, work 15 sts mrib starting with (p2,k2)repeat, ending k1; {k1, p2, BC 6, p2, k1 (center sleeve panel)}; work 15 sts mrib starting with (p2, k2)repeat, k1.

Work in established patterns increasing inside the selvage st on RS Rows 7, 13, 19, 25, 31, 37, 43.

Work through Row 48. BO 4 sts at beg of Rows 49 and 50. Then decrease 1 st each edge (k1, k2 tog, work to last 3 sts, ssk, k1) every RS row 14 times (22 sts). BO 3 sts at beg of Rows 79 and 80. BO 4 sts at beg of Rows 81 and 82. BO rem 8 sts.

Left Front :

Cast on 40 sts.

Row 1 (The Foundation Row): K1, work 21 sts mrib starting with (p2, k2) repeat, ending k1; work pattern pane as follows -- {k1, BP 3, BC 6, BP 3, k1}; work 4 st seed pattern for Button Band (see Pattern Stitches).

Keeping the stitch patterns consistent as established on the Foundation Row, follow the charts or written instructions for each pattern and continue as follows:

Rows 2 - 10: Dec 1 st at side edge on Rows 3, 5, 7, 9 -- k1, k2 tog, work to end.

Rows 11 - 13: Work in pattern

Rows 14 - 26: Inc 1 st at side edge on Rows 14, 18, 22, 26 -- work to last st, Bl, p1

Shape Yoke

Row 27 (RS): K1, work 20 sts mrib, k2 tog, BP 3, BC 6, BP 3, k1, Blpurl, 4 seed st

Continue in this manner, decreasing 1 st by k2 tog in the last 2 sts of mrib before pattern panel AND increasing 1 st by Bl after k1 at end of pattern panel on every RS row.

AT THE SAME TIME, BO 4 sts at the beg of Row 31. Decrease 1 st at side edge (k1, k2 tog) on Rows 33, 35, 37, 39

AND

Neck Edge: BO 8 sts at beg of Row 48. Decrease 1 st at neck edge (ending each RS row with k2 tog, k1) on Rows 49, 51, 53, 55, 57, 59, 61 (17 sts).

Work to Row 66 and place rem 17 sts on holder.

Right Front :

Work as for Left Front, reversing shaping AND working buttonholes in Button Band on Rows 3, 12, 21, 30, 39, 48.

Buttonholes are made on stitch 3 of seed st band -- k or p 1 st, k or p2 tog, yo, k or p next/last st.

BO 4 st seed band on Row 50.

Join Shoulders :

Using a double bind-off (DBO -- see Glossary) join sweater fronts to sweater back follows: DBO 17 sts for shoulder, BO 17 sts for back neck, DBO 17 sts for shoulder.

Collar :

With MC using double-pointed needle, RS facing, pick-up: 18 sts starting at k1 st inside right front seed st band, 15 sts across back neck, 17 sts to k1 st inside left front seed st band.

Rows 1 - 3: Knit

Rows 4 - 6: K 2 tog, k to last 2 sts, ssk

Break yarn.

With WS facing, join CC at left collar edge (this is the opposite edge from where you just broke off MC).

Row 7: K1, *(yo, k2 tog), rep from * across (eyelet row)

Row 8- 10: K1, BI, k to last st, BI, k1

Rows 11 - 13: Knit

Row 14: BO

Finishing :

Collar:

Fold collar in half along the eyelet row, wrong sides together. On the inside of the sweater, slip-stitch bound-off edge of collar to the picked-up stitches along the neck edge. Sew front edges of the two collar halves together using an invisible stitch.

Body: Sew side and sleeve seams. Set in sleeves.

Edging: Using Size 3 crochet hook, work 1 row single crochet around the edges of the entire garment. Work 1 row single crochet around each cuff. Using crochet hook and CC, work 1 row of slip stitch around the single crochet edges.

Embroidery:

IMPORTANT:

Before beginning your embroidery, check the yarn you are going to use to make sure it is colorfast. Cut a 12" piece of each color. Fold the piece into thirds and tie a knot in the center. Dampen thoroughly in lukewarm water. Place on top of double paper towel, place a third paper towel on top of the yarn. Press hard to squeeze out all of the water. Let dry, then check to see if there is any indication of color bleeding out on the paper towels. If this happens DO NOT USE THIS YARN FOR YOUR JACKET.

The embroidery is worked on the reverse St st area of the front and back yokes. Use your creativity to work fantasy wild flowers along edges near the braided cable pattern and scatter few flowers in the center area. Use lazy daisy, French knot, bullion, straight, whip and outline stitches. Refer to pages 232/3 in Vogue Knitting, The Ultimate Knitting Book, Pantheon Books, NY, 1989, for further information on embroidery.

Finish: Block your garment and sew on the 6 heart buttons.

Download all three charts for printing :

[PDF format - best quality \(79 KB\)](#) || [.BMP \(263 KB\)](#)

If you have enjoyed knitting this pattern, you may enjoy KNITTING NOW, a newsletter for the Serious Knitter. Published 3 times per year, KNITTING NOW features original designs for sweaters, shawls, hats, gloves, mittens and scarves, etc along with interviews, articles and reviews.

[Click here](#) for subscription information. This pattern may be copied for distribution but should not be sold.

[Upcoming Knit Events](#) || [Retail Outlets](#) || [Free Patterns](#) || [Subscription Information](#)
[Back Issues](#) || [Links Page](#) || **HOME**

Copyright KnittingNow 1998-2002. All Rights Reserved.

KEY: MISTAKE RIB

 = Knit on RS, Purl on WS

 = Purl on RS, Knit on WS

MISTAKE RIB



KEY: BOBBLE CHART

 = Purl on RS, Knit on WS

 = Pass 2nd and 3rd sts over first st on left hand needle

 = K3 on the WS

 = Knit, Purl, Knit in next st

BOBBLE CHART

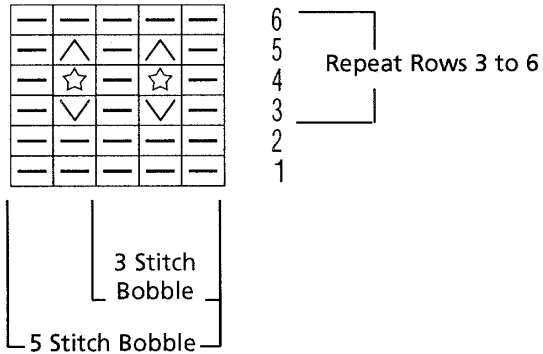

KEY: BRAIDED CABLE

 = Knit on RS, Purl on WS

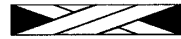
 = Slip 2 sts to cable needle and hold in back, K2, then K2 from cable needle

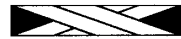
 = Slip 2 sts to cable needle and hold in front, K2, then K2 from cable needle

BRAIDED CABLE

